

Fisher-Price®

www.fisher-price.com

GeoTrax™
Rail & Road System

Mile High Mountain™

Parts

- A. Mountain Half (with Tunnel)
- B. Mountain Half (with Trees)
- C. Platform with Fence
- D. Mountain Top
- E. Chalet
- F. Snowy Trees
- G. Plain Trees
- H. Lower Spiral Track
- I. Upper Spiral Track
- J. Straight Track
- K. Small Ramp
- L. 4 Support Pillars
- M. Guardrail (plain)
- N. Guardrail with Tabs
- O. Tunnel
- P. Tunnel Track Support
- Q. Track with Barrier
- R. Lower Ramp
- S. Upper Ramp
- T. Crate
- U. Loader Engine
- V. #4 x 1/2" Screw - 8

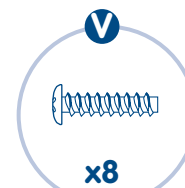
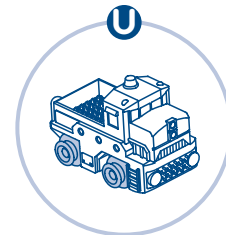
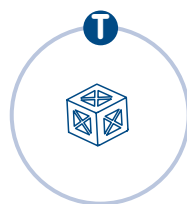
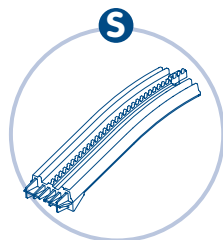
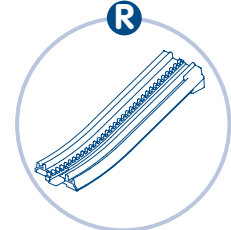
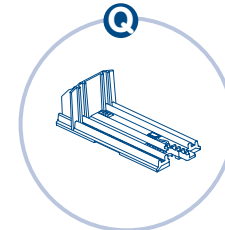
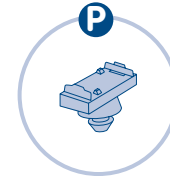
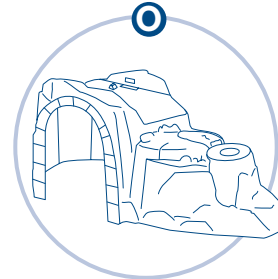
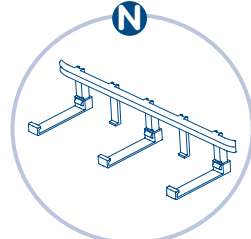
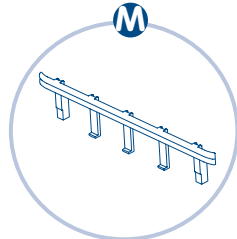
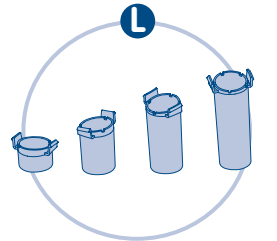
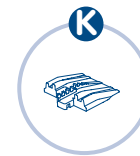
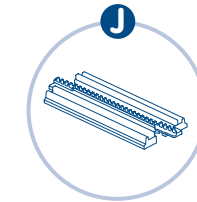
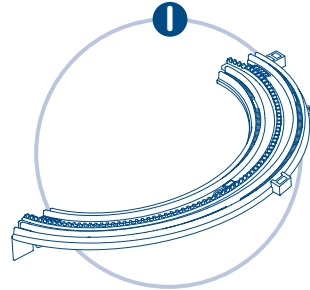
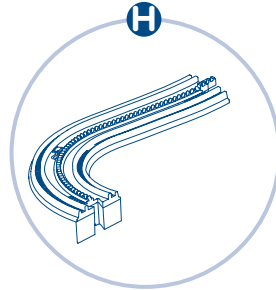
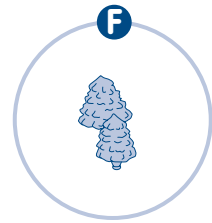
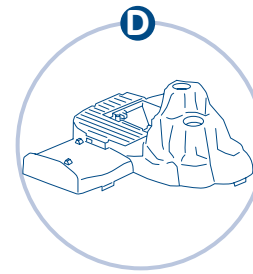
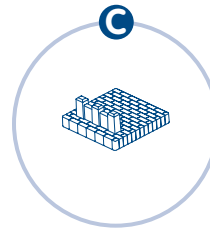
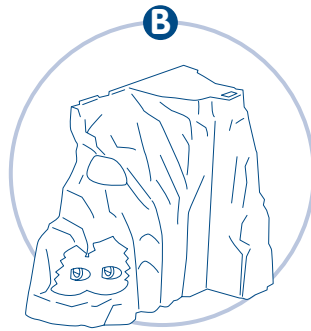
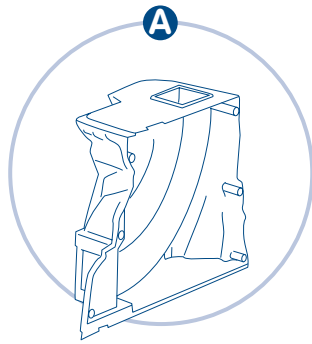

x8

Fastener Shown Actual Size

Please keep this instruction sheet for future reference, as it contains important information.

Adult assembly is required.

Tool required for assembly:
Phillips screwdriver
(not included).

⚠ WARNING

This product contains small parts in its unassembled state. Adult assembly is required.



Assembly

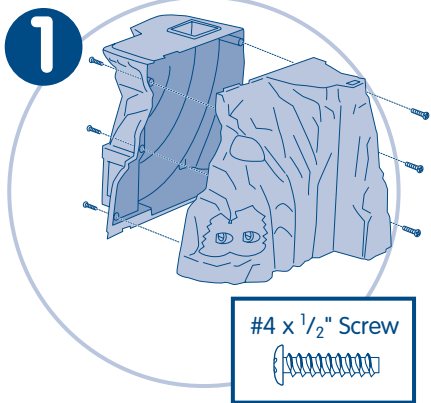

#4 x 1/2" Screw



- Fit the two mountain halves together, as shown.
- Insert six screws into the mountain assembly and tighten the screws with a Phillips screwdriver. Do not over-tighten.

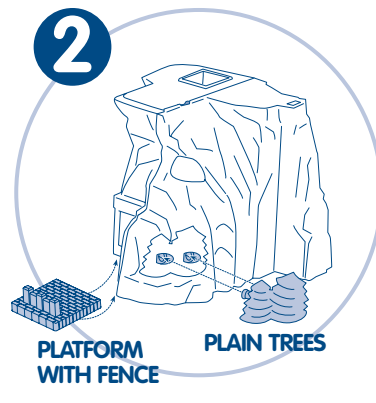

PLATFORM WITH FENCE
PLAIN TREES

- "Snap" the platform with the fence onto the mountain assembly.
- "Snap" the plain trees into the mountain assembly.



3 MOUNTAIN TOP

"Snap" the mountain top onto the mountain assembly.

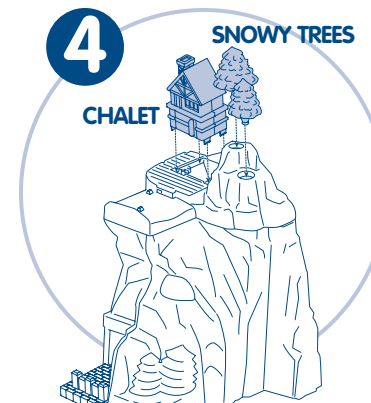

4 SNOWY TREES
CHALET

"Snap" the snowy trees and the chalet into the mountain top.

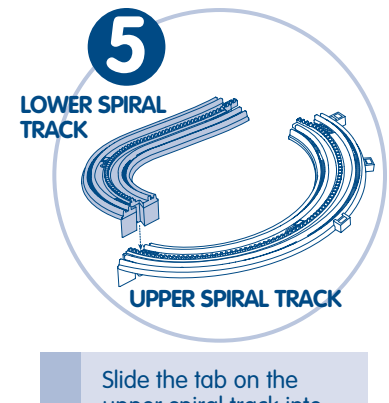

5 LOWER SPIRAL TRACK
UPPER SPIRAL TRACK

Slide the tab on the upper spiral track into the groove in the lower spiral track to join the two parts.

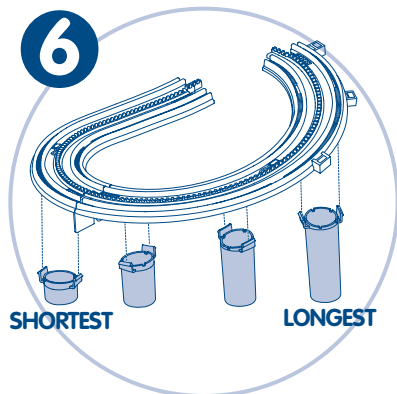

SHORTEST

LONGEST

"Snap" the support pillars to the underside of the spiral track assembly, as shown, working from the shortest pillar to the longest.

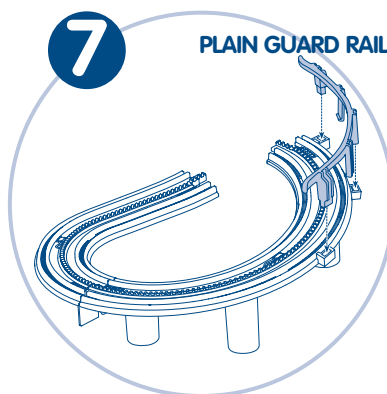

7 PLAIN GUARD RAIL

"Snap" the plain guardrail into the slots in the upper spiral track.



8 GUARDRAIL WITH TABS

- Locate the other guardrail with the tabs.
- Fit a tab on one end of the guardrail under the lower spiral track, as shown.
- Bend the guardrail slightly to fit the other two tabs to the lower spiral track.



9 TUNNEL TRACK SUPPORT

"Snap" the tunnel track support to the tunnel.

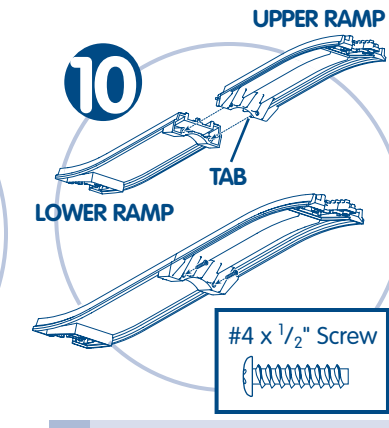

10 UPPER RAMP
LOWER RAMP
TAB

#4 x 1/2" Screw



- Fit the tabs on the upper ramp into the slots in the lower ramp.
- Insert two screws into the upper ramp. Tighten two screws with a Phillips screwdriver. Do not over-tighten.

Assembly is now complete!

Track Layouts

Try making the suggested layout shown here.

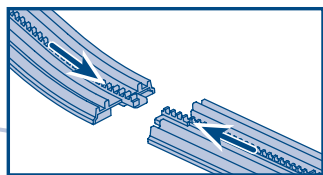

Track pieces easily snap together.

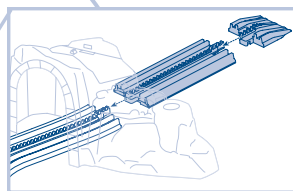
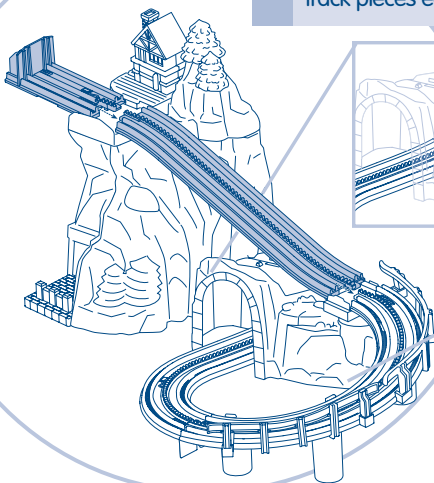

Set up this way to connect to the Tracktown Railway™ or Cross Valley Junction™ (each sold separately).

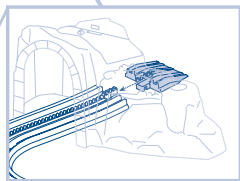
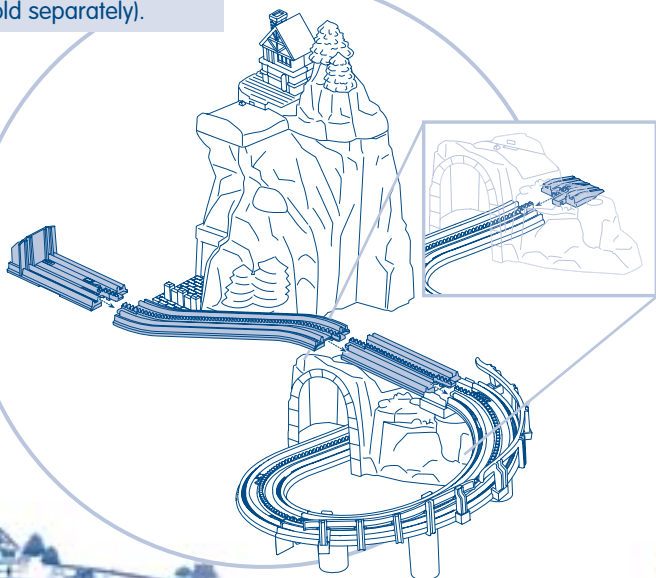

Load the Crate!



1
Load the crate into the chalet.



2
Close the chalet door.



3
The crate tumbles out the door at the bottom of the mountain.

The more you collect, the more fun it gets!



Add the C6449 Elevation Track Pack - Ramps (sold separately) to build this layout and climb to the top of the mountain.



For additional layout ideas, visit the GeoTrax™ section of www.fisher-price.com



Playsets and accessories sold separately and subject to availability.
Two of each Elevation Track Packs used to make this configuration.

Fisher-Price®

GeoTrax™
Rail & Road System

**For layout ideas visit the
GeoTrax™ section of
www.fisher-price.com**

Questions? We'd like to hear from you!

Call Fisher-Price® Consumer Relations, toll-free at **1-800-432-5437**,
8 AM - 6 PM EST Monday through Friday. Hearing-impaired
consumers using TTY/TDD equipment, please call 1-800-382-7470.
Or, write to: Fisher-Price® Consumer Relations, 636 Girard Avenue,
East Aurora, New York 14052, U.S.A.

Wipe the toy with a clean damp cloth.

For other countries outside the United States:

Canada: call 1-800-567-7724, or write to: Mattel Canada Inc., 6155 Freemont Blvd., Mississauga, Ontario L5R
3W2. **Great Britain:** telephone 01628 500302. **Australia:** Mattel Australia Pty. Ltd., 658 Church Street, Locked Bag
#870, Richmond, Victoria 3121 Australia. Consumer Advisory Service 1300 135 312. **New Zealand:** 16-18 William
Pickering Drive, Albany 1331, Auckland. **Asia:** Mattel East Asia Ltd, Room 1106, South Tower,
World Finance Centre, Harbour City, Tsimshatsui, HK, China.